

Micro cantilever user's manual

Thank you for purchasing OLYMPUS Micro cantilever.
Please read this manual carefully before use.

< Explanation of the each part of the products >

Cantilever chips in a plastic case are included in the envelope with manual and spec sheet.

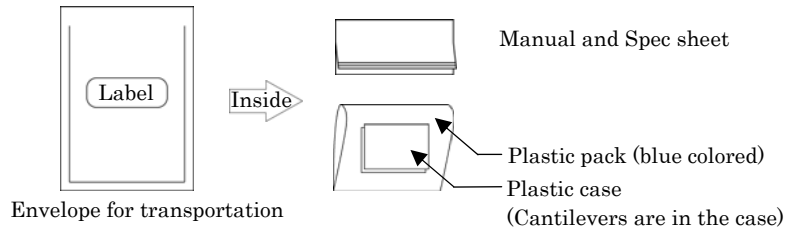

Cantilever chips are contained in the plastic case (Tac carrier)

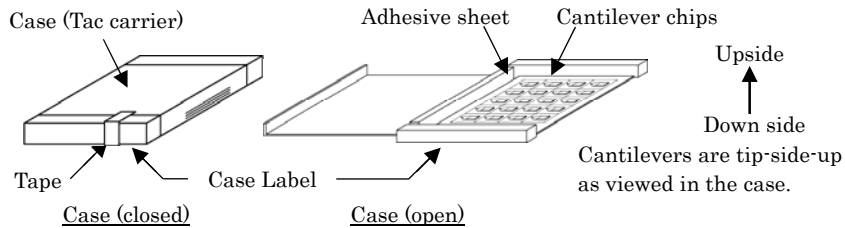

Magnified illust.

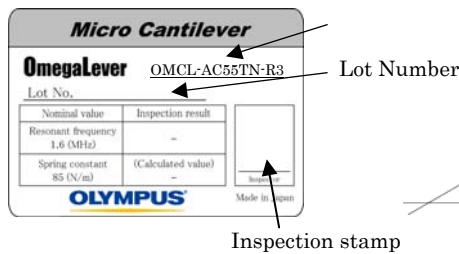

One cantilever is elongated from the side of round shoulders of the chip.

Please obey the following to the OLYMPUS micro cantilevers

Warning

- Use protective eye glasses when handling to avoid damage to the eyes from breakage of the cantilever chips.



Caution

- Please handle our cantilevers carefully because they are fragile.

Caution

- Do not drop or shake the cantilever case. Even when the cantilever chips are contained in the cantilever case, the cantilevers may break if the case is handled roughly or jarred.

Caution

- It is recommended that precautions be taken to prevent damage to the cantilever tips from electrostatic discharge.

Caution

- When discarding, please obey the laws and regulations in your country and/or your company. These cantilever are made from silicon.

Special feature of OLYMPUS Micro cantilever (OMCL-AC55TN-R3)

1. AC mode cantilever – This type of micro cantilever is for AC (dynamic) mode AFM operation. High mechanical Q factor of the cantilevers allows you high sensitivity measurement to probe your sample surface gently. Cantilever base material employs highly doped silicon with a surface resistance of 0.01-0.02 Ω · cm.
2. Mega Hertz range cantilever – Resonance frequency of this cantilever is over 1 MHz. The high resonance frequency with 1.6 MHz (Nom.) enables fast scanning measurement. It can be used at SPMs which bandwidth of the sensor circuit is 2.5 MHz or above.
3. Low thermal noise
Low thermal noise of cantilever vibration attributed to its high resonance frequency and high spring constant enables high resolution measurement.
4. Pre-separated chip – Each cantilever chips is isolated in the case.
The chips can be attached to the AFM instrument as soon as the case is open.
5. Tip View – The tip is located at the very end of the cantilever.
This feature allows you to set the tip over a point of interest on the sample, easily and precisely, if you use an AFM combined with an optical microscope.
6. Point terminated tip – The tip radius is typically 7nm.
A sharpened tetrahedral tip of single crystal silicon is employed for high-resolution measurements. The tetrahedral shape is ideal for achieving a point terminated tip. In addition to the geometrical dimensions of the tip, the tip is further sharpened with our exclusive sharpening process.
7. No metal reflex coating
8. Compatible chip – The thickness of the chip (substrate) is 0.3mm.
This type of the chip can be attached to most of AFM instruments.

See the specification sheet of OLYMPUS Micro cantilevers at the last page of this manual.

Table of contents

	page
1	Preparation 4e
2	Open the case 4e
3	Picking up the cantilever chip 4e
4	Tip shape of Tetrahedral tip 5e
5	Information 6e
6	Specification 1s

1 Preparation

- 1) Please prepare the followings before using OLYMPUS cantilevers.
- 2) To gain a better understanding of how cantilevers and chips are connected, cantilevers should be inspected under the microscope.

- 1) Work environment : Clean bench
(Use of an electrical charge neutralizer or ionizer is recommended.)
- 2) For hazard avoidance : Protective eye glasses
- 3) For cantilever treatment : Tweezers
(Use of anti-electrostatic discharge mat and a wrist band is recommended.)
- 4) For inspection : Stereo microscope

2 Open the case

 **Caution**

- Please handle our cantilevers carefully because they are fragile.

 **Caution**

- It is recommended that precautions be taken to prevent damage to the cantilever tips from electrostatic discharge.

- 1) It is recommended that the cantilever case be opened in a clean environment like a clean bench in order to avoid the cantilever being contaminated. Handling under an ionizer is recommended.
- 2) Avoid wearing clothes like woolen sweaters, fleece etc that give off the static electricity when handling the cantilever cases and chips. Use of an anti-electrostatic mat and wrist band is preferable.
- 3) In opening the case, put the plastic case label-side down on a desk.
The cantilevers are tip-side-up as viewed in the case.
- 4) Open the case

3 Picking up the cantilever chip from the case

 **Caution**

- Avoid any contact with the cantilevers when you pull up the cantilever tip from the case.

- 1) Pick up the chip by the long side with the tweezers and mount it in the AFM.

4 Tip shape of Tetrahedral tip

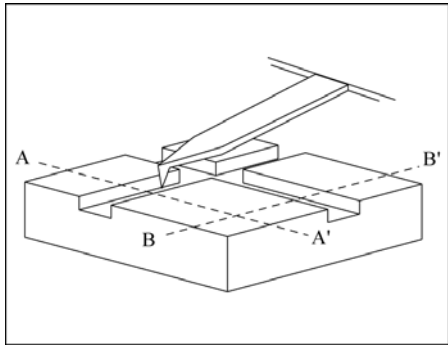

As can be seen in the left illustration, a tetrahedral tip is located at the exact end of the cantilever.

The finite tip shape will determine the scan line profile as in the illustrations below.

The tip profile is symmetric with a half tip angle of 18 degrees macroscopically (see left below).

The side tip profile is asymmetric with a tip angle of 35 degrees. Then the cantilever chip is attached to a chip holder in your AFM with an angle, about 10 degrees, the asymmetry is improved (see right below).

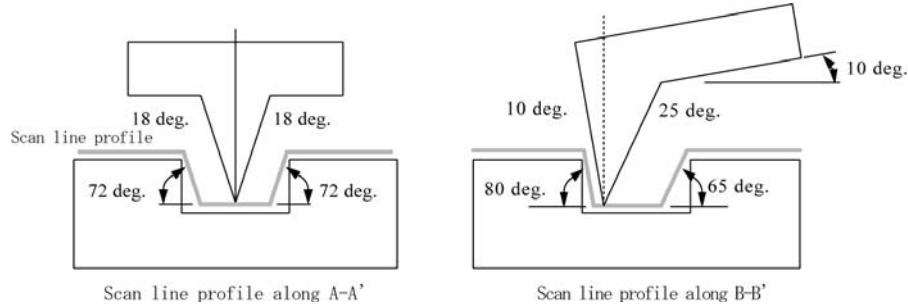

Tip shape and scan line profile

The apex of the tetrahedral tip becomes sharper due to an oxide sharpening process. The tip angle around a few hundreds nano meter down from the apex, is about 15 to 25 degrees (see below).

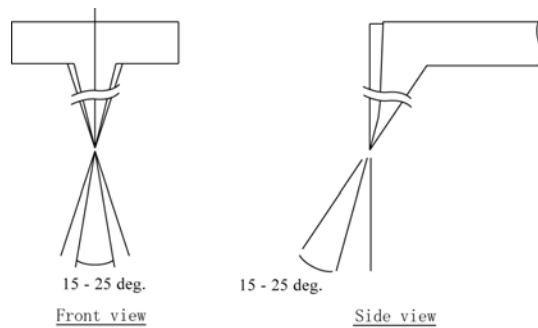

Sharpening effect around tip apex

5 Information

Please contact following if you have any question on this user's manual.

OLYMPUS CORPORATION
 Microtechnology R&D Division
 2-3 Kuboyama-cho Hachioji-shi Tokyo 192-8512 Japan
 email : probe@olympus.co.jp

Please access to the web page of OLYMPUS micro cantilevers.

<http://www.olympus.co.jp/probe>

Ver.1.0 August. 19, 2011
 OLYMPUS CORPORATION